



BACCARA

G75 Irrigation Controller



USERS GUIDE

08:00

TABLE OF CONTENTS

GETTING STARTED	1
FEATURES	1
PARTS IDENTIFICATION	1
BASIC CONTROLLER FUNCTIONS	2
INSTALLATION	2
MANUAL OPERATION	3
MAKING AN IRRIGATION SCHEDULE	3
<i>Irrigation Duration for P1/P2/P3.....</i>	<i>4</i>
<i>P1 Irrigation Schedule Design Table</i>	<i>4</i>
<i>P2 Irrigation Schedule Design Table</i>	<i>4</i>
<i>P3 Irrigation Schedule Design Table</i>	<i>4</i>
PROGRAMMING THE CONTROLLER	5
MEANING OF CONTROLLER ICONS	5
SETTING THE CLOCK	6
SETTING THE IRRIGATION DURATION	6
WATERING EVERY DAY AT A SET TIME (P1)	7
<i>Setting the Start Time</i>	<i>7</i>
<i>Example</i>	<i>8</i>
WATERING ON SELECTED DAYS (P2)	9
<i>Setting the Days</i>	<i>9</i>
<i>Example</i>	<i>10</i>
WATERING UP TO THREE TIMES A DAY ON SELECTED DAYS (P3)	11
<i>Setting the Start Times</i>	<i>11</i>
<i>Setting up a Second and Third Daily Irrigation</i>	<i>12</i>
<i>Choosing the Days.....</i>	<i>12</i>
<i>Example</i>	<i>13</i>
Maintenance and Troubleshooting	14
BATTERY INSTALLATION	14
OFF SEASON	15
TROUBLESHOOTING	16
Contact and Service Information	17
GUARANTEE	17
CONTACT INFORMATION	18

Getting Started

Features

- Up to three operations per day
- Battery powered; no need for electrical hookup
- Easy installation
- Waterproof and weather resistant
- Easy programming

Parts Identification

1. Top Cover
2. Controller Display
3. Solenoid
4. Controller
5. Water Flow Direction Arrow
6. Hydraulic Valve

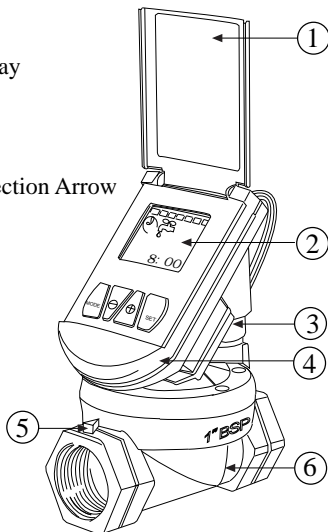



Basic Controller Functions



This section gives a brief description of the Controller buttons. See the following sections for further details.

MODE Button - Quick presses of the **MODE** button turn the controller off, or turn on a specific program (**P1, P2, or P3**). Longer presses of the **MODE** button put the Controller in programming mode.

SET Button - Press the **SET** button to set a function and proceed.

  - Use these buttons to increase and decrease schedule functions.

Installation

1. Turn off the main faucet.
2. Install the valve in the irrigation system so that the black arrow on the valve is pointing in the direction of the water flow. The Controller may be swiveled around to facilitate installation.
3. Occasionally the valve opens in transit. To ensure that the valve is closed before you open the main faucet, first make sure that the Controller is not set to OFF (If it is set to OFF, press briefly on the **MODE** button to turn it on.) Then press  and **SET** simultaneously to open, and press  and **SET** simultaneously to close, You are now ready to program the Controller.
4. Turn on the main faucet.

Manual Operation

To manually open the valve, make sure that the Controller is not set to OFF (If it is set to OFF, press briefly on the **MODE** button), then press ⊕ and **SET** simultaneously.

The irrigation will continue until the interval defined has passed. If the irrigation duration has been set to zero, the valve will close after one minute.

To stop irrigating, press ⊖ and **SET** simultaneously.

Making an Irrigation Schedule

If you are planning to water either on selected days only (**P2**), or up to three times a day on selected days (**P3**) it is important to make a watering plan before programming the Controller. The plan should list the days you want to water, the number of times you wish to water each day, and at what time you want the watering to start.

Consult this plan while programming the Controller.

Irrigation Duration for P1/P2/P3

Duration Time	
---------------	--

P1 Irrigation Schedule Design table

Start Time						
Sun.	Mon.	Tue.	Wed.	Thurs.	Fri.	Sat.
✓	✓	✓	✓	✓	✓	✓

P2 Irrigation Schedule Design table

Start Time		As set in P1				
Sun.	Mon.	Tue.	Wed.	Thurs.	Fri.	Sat.

P3 Irrigation Schedule Design table

		Start 1	Start 2	Start 3		
Start Time						
Sun.	Mon.	Tue.	Wed.	Thurs.	Fri.	Sat.

Programming the Controller

Meaning of Controller Icons

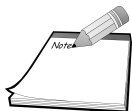

NOTE: Quick presses of the **MODE** button turns the Controller off, or turns on a specific program (**P1**, **P2** or **P3**).

Longer presses of the **MODE** button put the Controller in programming mode.

1. Irrigating days of the week
2. Program starts
3. Program #
4. Irrigation
5. Timing or clock
6. Low battery
7. Time adjustment

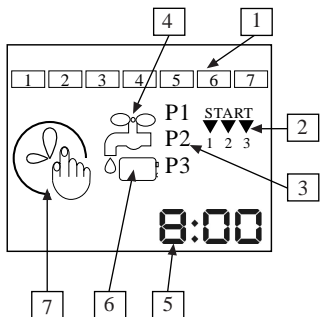

NOTE: You cannot program the controller if it is set to manual operation (Page 3) or if it is set to "OFF". To release from manual operation press \ominus and **SET** simultaneously. To release from OFF press briefly on the **MODE** button.

Controller will revert to operating mode after 30 seconds if no buttons are pressed.

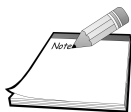

Setting the Clock

If screen is blank, press **MODE** to activate.

Before programming the controller you must set the clock.

1. Press **MODE** for several seconds until the time adjustment icon appears (The minutes will be flashing):

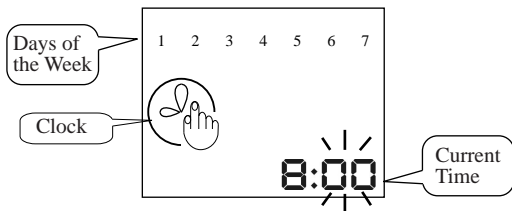

On this screen the numbers represent the current time.

2. Use the \oplus and the \ominus buttons to adjust the minutes.
3. Press **SET** to continue.
4. Use the \oplus and the \ominus buttons to adjust the hours.
5. Press **SET** to continue.
6. Use the \oplus and the \ominus buttons to select the current day of the week. The selected day will flash.
7. Press **SET** to return to operating mode.

Setting the Irrigation Duration

To set duration of all irrigations, you must be in an operating mode (**P1**, **P2**, or **P3**).

1. Press the **MODE** button until the clock setting screen appears, then press **MODE** again until the following screen appears (the minutes will be flashing).

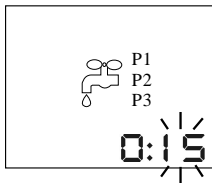

On this screen, the clock numbers refer to the amount of time you wish irrigation to continue.

2. Use the \oplus and the \ominus buttons to adjust the minutes.
3. Press **SET** to continue.
4. Use the \oplus and the \ominus buttons to adjust the hours.
5. Press **SET** to continue.

Watering Every Day at a Set Time (P1)

If you would like to water your garden every day at a constant same time use the **P1** program:

Setting the Start Time

After setting the irrigation duration time, the following screen appears:

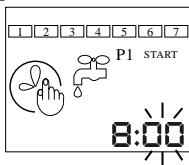

On this screen, the clock numbers refer to the time you wish irrigation to begin.

1. Use the ⊕ and the ⊖ buttons to adjust the minutes
2. Press **SET** to continue.
3. Use the ⊕ and ⊖ buttons to adjust the hours.
4. Press **SET** to return to operating mode (**P1** programming is now complete).

Example

If you wish to irrigate every day at 8:00 in the morning, for 15 minutes: Make sure the clock is set, and you are in an operating mode. Press **MODE** twice to get to the the Duration Time (with the tap). Set the Duration Time to 0:15. Then set the clock (on the following screen with the watch face and tap) to 8:00.

Watering on Selected Days (P2)

If you would like to water your garden on specific days at the same time use **P2** program:

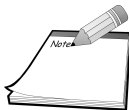

Irrigation duration must be set first. See page 7. **P2** takes the start time directly from **P1**. For instructions on how to set **P1** see page 7.

Setting the Days

- To set the days, press **MODE** until the clock setting screen appears, then press **MODE** again until the Duration Time (with tap) appears, then press **MODE** again until the **P1** screen appears, and press once again until the following screen appears:

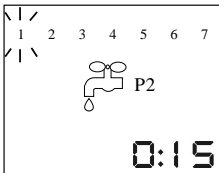

- Press **SET** to reach the day you wish to irrigate. The number (corresponding to the day of the week) will flash.
- Press \oplus to select that day (the square which appears indicates day is selected).
- Press \ominus to deselect a day.
- Press **SET** until all days are programmed as desired. Current day continues flashing.
- Press **SET** to return to operating mode.

Example

If you wish to irrigate Sunday, Tuesday, Thursday and Saturday at 8:00 in the morning, for 15 minutes: Make sure the clock is set, and you are in an operating mode. Then press **MODE** twice to get to the Duration Time (with tap). Set the duration time to 0:15. Then set the clock (on the following screen with the clock face and tap) to 8:00. Press **MODE** to get to the **P2** screen, then select days 1, 3, 5 and 7.

Watering Up-To Three Times a Day on Selected Days (P3)

If you need to water more, up-to three times a day, on specific days, use the **P3** program.

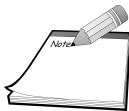

Duration time must be programmed first. See page 7.

Setting the Start Times

To set start times, you must be in an operating mode (**P1**, **P2**, or **P3**).

1. Press **MODE** until the clock setting screen appears, press **MODE** again until the Duration Time (with tap) screen appears, press **MODE** a third time until the **P1** screen appears, press again until **P2** appears, then press again until the **P3** screen appears (The minutes will be flashing).

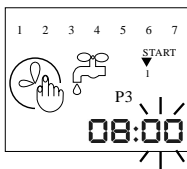

On this screen, the clock numbers refer to the time you wish the first irrigation (**START 1**) to begin. The three arrows under **START** indicate the three different irrigations. As each arrow appears you may program the start time for that particular irrigation.

2. Use the \oplus and the \ominus buttons to adjust the minutes.
3. Press **SET** to continue.
4. Use the \oplus and \ominus buttons to adjust the hours.
5. Press **SET** to continue programming. The arrow now appears under **START 2**.

Setting up a Second and Third Daily Irrigation

Repeat the above steps for setting the start times of the second and third daily irrigations. After completing setting the start times, the number 1 in the upper left corner will flash indicating that you are now ready to choose the days you wish to irrigate.

Choosing the Days

1. Press **SET** to move through the days, and reach the day you wish to irrigate. The number (corresponding to the day of the week) will flash.
2. Press \oplus to select that day (the square which appears indicates day is selected).
3. Press \ominus to deselect a day.
4. Continue through all the days until day 7 is flashing, then either press **SET** to return to operating mode or press \oplus to select 7 (if desired) and then press **SET**.

Example

If you wish to irrigate Sunday, Tuesday, Thursday and Friday at 8:00 in the morning, and at noon, and at 15:00 in the afternoon for 3 minutes each time, first make sure the clock is set, and duration time is set to 0:30. Then press **MODE** until the clock setting screen appears, press **MODE** again until the Duration Time (with tap) screen appears, press **MODE** a third time until the **P1** screen appears, press again until **P2** appears, then press again until the **P3** screen appears (with clock face and tap). Set 1 to 8:00, Start to 12:00, and Start 3 to 15:00. After setting the irrigation start times, the days at the top of the screen will flash. Set 1, 3, 5 then press **SET** when you reach day 7.

Maintenance and Troubleshooting

Battery Installation

Replace the battery at the start of each irrigation season and when the low battery symbol  appears.

1. Using a Phillips screwdriver, remove the four battery cover screws.
2. Remove the battery cover and seal.
3. Replace the battery.
4. After reattaching the seal, put the cover back, and secure with the four screws.

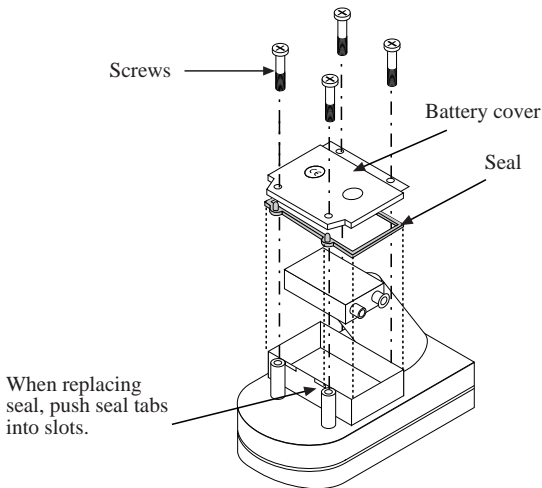

Off Season

During the season when you do not need to water your plants press the **MODE** button quickly until **OFF** is displayed. **DO NOT** remove the battery. The Controller is equipped with a back-up battery, and removing the main battery for long periods will cause the back-up battery to discharge.

Troubleshooting

PROBLEM	CAUSE	SOLUTION
Controller does not irrigate plants as desired	Water at main faucet is shut off	Check faucet
	Hose cut or blocked	Replace damaged section
	Battery dead	Replace battery
	Controller set on OFF	Set controller to desired program
	Controller improperly programmed	Check program and clock settings
Blank display	Battery dead	Replace battery
	Controller in sleep mode	Press MODE to activate screen
Water does not turn off	Valve blocked by dirt or scale	Replace valve
	Valve installed backwards	Install valve so that the arrow points in the direction of the water flow



Cautions *Do not remove the battery when the Controller is not in use*

Contact and Service Information

Guarantee

Baccara products are guaranteed to be free from defects in material and workmanship for a period of one year from the date of delivery.

This guarantee does not apply where equipment is not used and installed strictly in accordance with *Baccara* specifications and Users Guide. Neither does it apply to failures caused by lightning strikes or damage due to freezing temperatures or mechanical causes (e.g. lawn mowers). *Baccara* is not liable for indirect, incidental or consequential damage in connection with the use of equipment.

To receive guarantee benefits, customers should return defective units along with the receipt to the nearest *Baccara* distributor.

Baccara reserves the right to alter, modify or redesign its products, pricing and guarantee at all times without creating any liability for the obsolescence of customer inventory of such parts or products.

This manufacturer guarantee policy may apply differently in different countries.

Contact information

FACTORY AND HEAD OFFICE
Baccara Automation Control
Kvutzat Geva, 18915, Israel

Tel: 972 4 6535 960

Fax: 972 4 6531 445

E-mail: baccara@netvision.net.il

Web Site: www.baccara.co.il



Flow Chart for G75 Irrigation Controller

